

# Owner's Manual

---

## **SPLIT TYPE FLOOR STANDING AIR-CONDITIONER**

model

PCOL-52R32+++

Please pay attention to the following:

- ※ The installation should be carried out by specialists.
- ※ In order to use it safely, correctly and efficiently, please read the instructions carefully and keep the instructions for reference in the future.
- ※ Make sure of grounding connection of the air-conditioner.

# CONTENTS

## Operation and maintenance

<b>WARNING</b> .....	1
<b>Safety precautions</b> .....	2
<b>Notices for usage</b> .....	6
<b>Names of each part</b> .....	7
<b>Operation manual of the control panel</b> .....	8
<b>Clean and care</b> .....	9
<b>Troubleshooting</b> .....	11

## Installation service

<b>Notices for installation</b> .....	13
<b>Installation for indoor unit</b> .....	17
<b>Installation for outdoor unit</b> .....	20
<b>Check after installation and test operation</b> .....	23
<b>Maintenance Notice</b> .....	24

## Electronic manual







<b>Remote controller instructions</b> .....	30
<b>WIFI instructions</b> .....	30

**Note:** All the illustrations in this manual are for explanation purpose only. Your air conditioner may be slightly different. The actual shape shall prevail. They are subject to change without notice for future improvement.

**WARNING: This air conditioner uses R32 flammable refrigerant.**

**Notes: Air conditioner with R32 refrigerant, if roughly treated, may cause serious harm to the human body or surrounding things.**

- \* The air conditioner should be stored in a well-ventilated room, storage room area: 51, 72 frequency conversion air conditioner should be more than 18 m<sup>2</sup>; 72 fixed frequency air conditioning should be greater than 30 m<sup>2</sup>; 120 frequency conversion air conditioning should be greater than 46 m<sup>2</sup>, 120 fixed frequency air conditioning should be greater than 63 m<sup>2</sup>.
- \* Do not use means to accelerate the defrosting process or to clean, other than those recommended by the manufacturer.
- \* Not pierce or burn air conditioner, and check the refrigerant pipeline whether be damaged.
- \* The appliance shall be stored in a room without continuously operating ignition sources (forexample: open flames, an operating gas appliance or an operating electric heater.
- \* Notice that the refrigerant may be tasteless.
- \* The storage of air conditioner should be able to prevent mechanical damage caused by accident.
- \* Maintenance or repair of air conditioners using R32 refrigerant must be carried out after security check to minimize risk of incidents.
- \* Air conditioner must be installed with stop valve cover.
- \* Please read the instruction carefully before installing, using and maintaining.

Symbol	Note	Explanation
	WARNING	This symbol shows that this appliance uses a flammable refrigerant. If the refrigerant is leaked and exposed to an external ignition source, there is a risk of fire. (Only for the AC with CE-MARKING)
	WARNING	This symbol shows that this appliance uses a flammable refrigerant. If the refrigerant is leaked and exposed to an external ignition source, there is a risk of fire. (Only for the AC with CB-MARKING, IEC 60335-2-40+A1:2016)
		This symbol shows that this appliance uses a low burning velocity material. (Only for the AC with CB-MARKING, IEC 60335-2-40:2018)
	CAUTION	This symbol shows that the operation manual should be read carefully.
	CAUTION	This symbol shows that a service personnel should be handling this equipment with reference to the installation manual.
	CAUTION	This symbol shows that information is available such as the operating manual or installation manual.

# Safety precautions

The requirements for room service area and maximum refrigerant charge are shown in the table below.

room area (m <sup>2</sup> )	maximum refrigerant charge (kg)	room area (m <sup>2</sup> )	maximum refrigerant charge (kg)
17 ~ 19	1.40	45 ~ 49	2.25
20 ~ 24	1.50	50 ~ 54	2.40
25 ~ 29	1.70	55 ~ 59	2.50
30 ~ 34	1.85	60 ~ 64	2.70
35 ~ 39	2.00	65 ~ 69	2.80
40 ~ 44	2.15		

**Incorrect installation or operation by not following these instructions may cause harm or damage to people, properties, etc.**

**The seriousness is classified by the following indications:**

## **WARNING**

This symbol indicates the possibility of death or serious injury.

## **CAUTION**

This symbol indicates the possibility of injury or damage to properties.

## **WARNING**

**This appliance can be used by children aged from 8 years and above and persons with reduced physical, sensory or mental capabilities or lack of experience and knowledge if they have been given supervision or instruction concerning use of the appliance in a safe way and understand the hazards involved. Children shall not play with the appliance.**

**Cleaning and user maintenance shall not be made by children without supervision. (Only for the AC with CE-MARKING)**

**This appliance is not intended for use by persons (including children) with reduced physical, sensory or mental capabilities, or lack of experience and knowledge, unless they have been given supervision or instruction concerning use of the appliance by a person responsible for their safety.**

**Children should be supervised to ensure that they do not play with the appliance. (Except for the AC with CE-MARKING)**

# Safety precautions

**The air conditioner must be grounded. Incomplete grounding may result in electric shocks.**



Do not connect the earth wire to the gas pipeline, water pipeline, lightning rod, or telephone earth wire.

**Cut off the main power switch when the unit is not in use for long time so as to ensure safety.**



**Don't use air conditioner in lightning storm weather.**

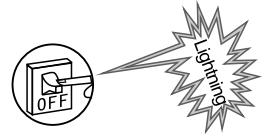

Power supply should be cut in time to prevent the occurrence of danger.

**Don't block air inlet or air outlet.**

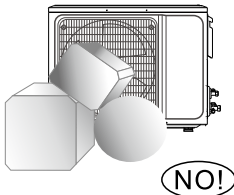

Otherwise, the cooling or heating capacity will be weakened, even cause system stop operating.

**Don't install air conditioner in a place where there is flammable gas or liquid. The distance between them should be above 1m.**

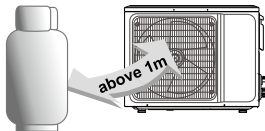

It may cause fire.

**Take care not let the remote control and the indoor unit watered or being too wet.**

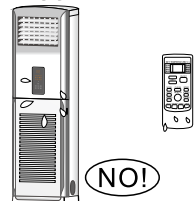

Otherwise, it may cause short circuit even fire.

**Don't use liquid or corrosive cleaning agent wipe the air conditioner and sprinkle water or other liquid either.**

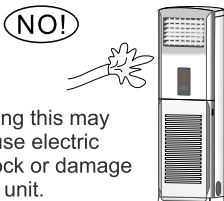

Doing this may cause electric shock or damage the unit.

**Don't put hands or any objects into the air inlets or outlets.**

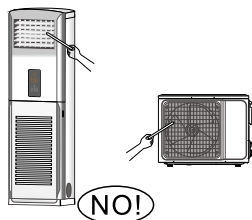

This may cause personal injury or damage to the unit.

**An earth leakage breaker with rated capacity must be installed to avoid possible electric shocks.**

**The appliance shall be installed in accordance with national wiring regulations.**

# Safety precautions

Regarding the installation of the air conditioners, please refer to the below paragraphs in this manual.

This product contains fluorinated greenhouse gases.

Refrigerant leakage contributes to climate change. Refrigerant with lower global warming potential (GWP) would contribute less to global warming than a refrigerant with higher GWP, if leaked to the atmosphere. This appliance contains a refrigerant fluid with a GWP equal to [675]. This means that if 1 kg of this refrigerant fluid would be leaked to the atmosphere, the impact on global warming would be [675] times higher than 1 kg of CO<sub>2</sub>, over a period of 100 years. Never try to interfere with the refrigerant circuit yourself or disassemble the product yourself and always ask a professional.

The joints between indoor and outdoor unit shall not be reused, unless after re-flaring the pipe.

The specification of the fuse are printed on the circuit board, such as: 3.15A/250V AC, etc.

## WEEE Warning

**Meaning of crossed out wheeled dustbin:**

Do not dispose of electrical appliances as unsorted municipal waste, use separate collection facilities.

Contact your local government for information regarding the collection systems available.

If electrical appliances are disposed of in landfills or dumps, hazardous substances can leak into the groundwater and get into the food chain, damaging your health and well-being.

When replacing old appliances with new ones, the retailer is legally obligated to take back your old appliance for disposals at least free of charge.

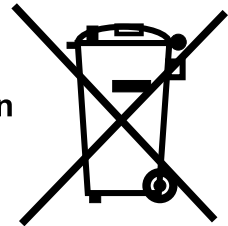

# Safety precautions

## ⚠ CAUTION

**Don't open the windows and doors for long time when the air conditioner is running.**

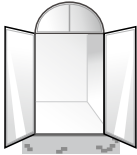

Otherwise, the cooling or heating capacity will be weakened.

**Don't stand on the top of the outdoor unit or place heavy things on it.**

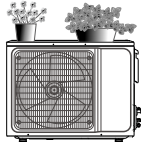

This could cause personal injuries or damage the unit.

**Don't use the air conditioner for other purposes, such as drying clothes, preserving foods, etc.**

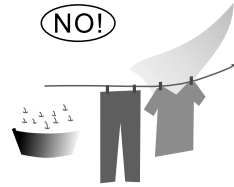

**Don't apply the cold air to the body for a long time.**

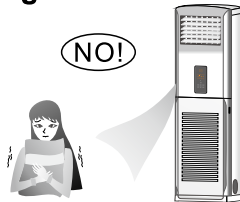

It will deteriorate your physical conditions and cause health problems.

**Set the suitable temperature.**

It is recommended that the temperature difference between indoor and outdoor temperature should not be too large.



Appropriate adjustments of the setting temperature can prevent the waste of electricity.

**If your air conditioner is not fitted with a supply cord and a plug, an all-pole switch must be installed in the fixed wiring and the distance between contacts should be no less than 3.0 mm.**

**If your air conditioner is permanently connected to the fixed wiring, a residual current device (RCD) having rated residual operating current not exceeding 30 mA should be installed in the fixed wiring.**

**If the supply cord is damaged, it must be replaced by the manufacturer, its service agent or similarly qualified persons in order to avoid a hazard.**

**The power supply circuit should have leakage protector and air switch of which the capacity should be more than 1.5 times of the maximum current.**

# Notices for usage

## The conditions of unit can't normally run

\* Within the temperature range provided in following table, the air conditioner may stop running and other anomalies may arise.

Cooling	Outdoor	>43°C (Apply to T1)	Heating	Outdoor	>24°C
		>52°C (Apply to T3)			<-15°C
	Indoor	<18°C		Indoor	>27°C

- \* When the temperature is too high, the air conditioner may activate the automatic protection device, so that the air conditioner could be shut down.
- \* When the temperature is too low, the heat exchanger of the air conditioner may freeze, leading to water leakage or other malfunction.
- \* In long-term cooling or dehumidification with a relative humidity of above 80% (doors and windows are open), there may be water condenses or dripping near the air outlet.
- \* T1 and T3 refer to ISO 5151.

## Notes for heating

- \* The fan of the indoor unit will not work immediately when the heating is started to avoid blowing out cool air.
- \* When it is cold and wet outside, the outdoor unit will develop frost over the heat exchanger which will compromise the heating capacity. This is when the air conditioner will start defrost.
- \* During defrost, the air conditioner will stop heating for about 5-12 minutes.
- \* Vapor may come out from the outdoor unit during defrost. This is not a malfunction, but a result of fast defrost.
- \* Heating will resume after defrost is complete.

## Notes for ambient temperature display

- \* To prolong the useful life of the compressor, the AC controller will turn ON/OFF the compressor automatically according to the actual conditions, and it is normal that the unit may not be turned off immediately after the ambient temperature reaches the set temperature, but after a delay.
- \* As the temperature is not uniform throughout the room, the air conditioner will make compensation automatically to improve the comfort, it is normal that the temperature displayed is not the same as measured by the user.

## Notes for turning off

- \* When the air conditioner is turned off, the main controller will automatically decide whether to stop immediately or after running for dozens of seconds with lower frequency and lower air speed.

## ATTENTION

If the equipment emissions cannot meet the technical requirement of IEC 61000-3-3, following attention should be take care.

**Attention:** This appliance can be connected only to a supply with system impedance no more than  $Z_{max}$ . In case necessary, please consult your supply authority for system impedance information.

Product Type	$Z_{max}$	#=APA,APC,APD,APE,APF,APG,APH,API
ASF-H48B5/#R1-EU;ASF-H48C5/#R1-EU	0.273	

# Names of each part

## Indoor unit

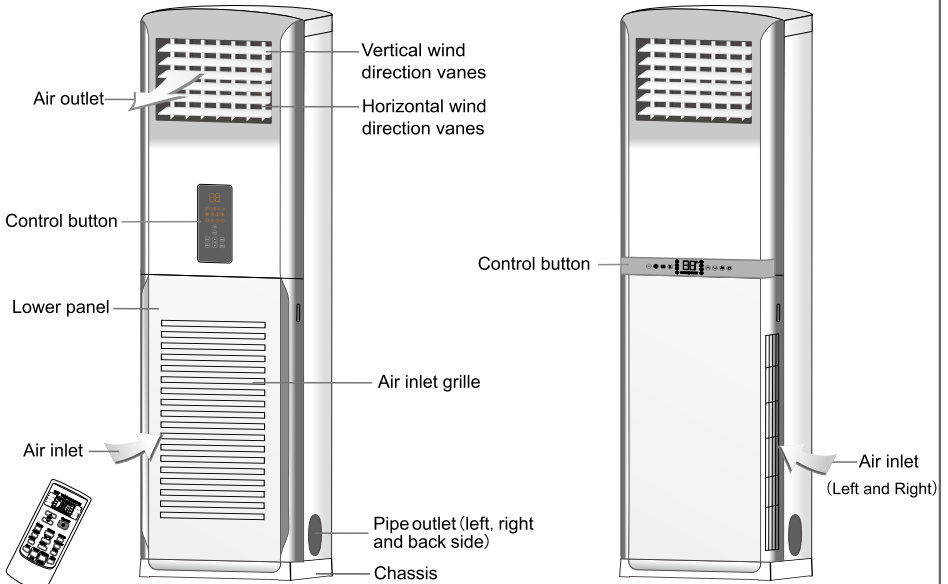

Remoter controller



## Outdoor unit

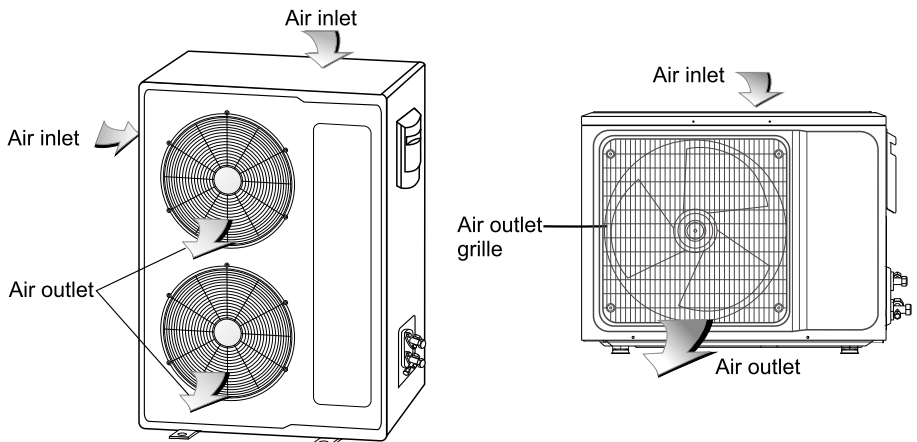

Note: All the illustrations in this manual are for explanation purpose only. Your air conditioner may be slightly different. The actual shape shall prevail. They are subject to change without notice for future improvement.

# Operation manual of the control panel

## Display

There are two kinds about control panel, Fig A and Fig B, the actual shape shall prevail.

**Note:** According to different models and operation modes, air-conditioner under operation would only display parts of the above contents, please comply with actual article.

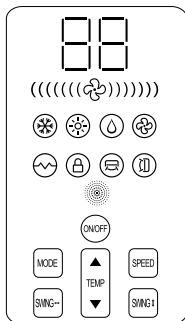

Fig A

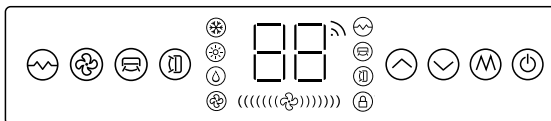

Fig B

## Control button



Press this button, the unit will start or stop, which can clear the timer or sleeping function of last time.



Press this button, the running mode will change as below:

COOL → DRY → HEAT → FAN

**Note: cooling only unit has no heating function.**



You can select fan speed as the following: [ LOW → MID → HIGH ]



Press this button to open left/right(up/down) swing function, if press it again, the position will be turned off.



With the memory function for the air swing, the original setting will remain valid after the unit is turned off and on again.



Press the “▲/⬆” or “▼/⬇” button, set the temperature, temperature can be set at 1°C difference range from 16-32°C.



**Note: the TEMP button is invalid in fanning mode.**



If this button is pressed in HEAT mode, the electric heating will be turned on/off.

**Note: Some units don't have this button.**

## ⚠ CAUTION

- Before the cleaning of the air conditioner, it must be shut down and the electricity must be cut off for more than 5 minutes, otherwise there might be the risk of electric shocks.
- Do not wet the air conditioner, which can cause an electric shock. Make sure not to rinse the air conditioner with water under any circumstances.
- Volatile liquids such as thinner or gasoline will damage the air conditioner housing, therefore please clean the housing of air conditioner only with soft dry cloth and damp cloth moistened with neutral detergent.
- In the course of the usage, pay attention to cleaning the filter regularly, to prevent the accumulation of dust which may affect the air conditioner performance . If the service environment of the air conditioner is dusty, correspondingly increase the number of times of cleanings.
- After removing the filter, do not touch the fin part of the indoor unit with the finger, so as to avoid scratching it.

## Clean the panel

- Clean the air conditioner with a piece of soft and dry cloth. When the panel of the indoor unit is contaminated, clean it gently with a wrung towel using tepid water below 40°C .
- Don't splash water on the indoor unit.  
As the indoor unit of the air conditioner contains micro-computer components and circuit boards, no damping and soaking is allowed.

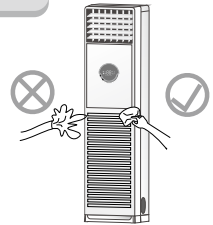

## Clean the air filter

### ■ Take off the air filter

Remove the screw on the top of the inlet panel. Grasp the inlet panel and gently pull forward to yourself, then pull out the air filter.

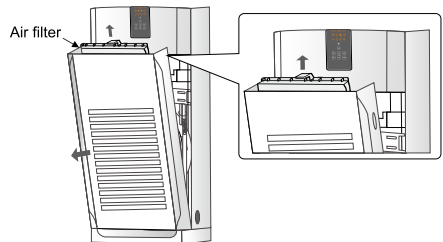

### ■ Clean the air filter

To clean the dust adhering to the filters , you can either use a vacuum cleaner, or wash them with warm water(the water with the neutral detergent should below 40°C) , and dry it in the shade.

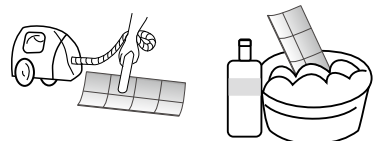

### ■ Insert the air filter

Insert the air filter into the slot in the direction opposite to when it is removed.

# Clean and care

## Clean the air filter

- The cleaning and maintenance of the filter must be finished by the manufacturer or its service agent or a similar qualified person.
- If conditions do not allow by qualified person to clean, please make sure the air conditioners completely without electricity for three minutes and motion mechanism under the condition of full stop then clean. (because of the air conditioner interior with high voltage and motion mechanism, maybe lead to electric shock and injury risk)

## Check before use

1. Check whether all the air inlets and outlets of the units are unblocked.
2. Check whether there is blocking in the water outlet of the drain pipe, and immediately clean it up if any.
3. Check the ground wire is reliably grounded.
4. Check whether the remote control batteries are installed, and whether the power is sufficient.
5. Check whether there is damage in the mounting bracket of the outdoor unit, and if any, please contact our local service center.

## Maintain after use

1. Cut off the power source of the air conditioner, turn off the circuit breaker and remove the batteries from the remote control.
2. Clean the filter and indoor and the outdoor unit body.
3. Remove the dust and debris from the outdoor unit.
4. Check whether there is damage in the mounting bracket of the outdoor unit, and if any, please contact our local service center.

# Troubleshooting

## ⚠ CAUTION

\* Do not repair the air conditioner by yourself as wrong maintenance may cause electric shock or fire, please contact the authorized service center and let the professionals conduct the maintenance, and checking the following items prior to contacting for maintenance can save your time and money.

### Phenomenon

### Troubleshooting

The air conditioner does not work.

- There might be power outages. → Wait until power is restored.
- Power plug may be loose out from the socket.  
→ The plug in the plug tightly.
- Power switch fuse may blow. → Replace the fuse.
- The time for timing boot is yet to come.  
→ Wait or cancel the timer settings.

The air conditioner can't run after the immediate start-up after it is shut down.

- If the air conditioner is turned on immediately after it is turned off, the protective delay switch will delay the operation for 3 to 5 minutes.

The air conditioner stops running after it starts up for a while.

- May have reached the setting temperature.  
→ It is a normal function phenomenon.
- May be at a defrosting state. → It will automatically restore and run again after defrosting.
- Shutdown Timer may be set.  
→ If you continue to use, please turn it on again.

The wind blows out, but the cooling/heating effect is not good.

- Excessive accumulation of dust on filter, blocking at air inlet and outlet, and the excessively small angle of the louver blades all will affect the cooling and heating effect.  
→ Please clean the filter, remove the obstacles at the air inlet and outlet and regulate the angle of the louver blades.
- Poor cooling and heating effect caused by doors and windows opening, and unclosed exhaust fan.  
→ Please close the doors, windows, the exhaust fan, etc.
- Auxiliary heating function is not turned on while heating, which may lead to poor heating effect.  
→ Turn on the auxiliary heating function.  
(only for models with auxiliary heating function)
- Mode setting is incorrect, and the temperature and wind speed settings are not appropriate.  
→ Please re-select the mode, and set the appropriate temperature and wind speed.

The indoor unit blows out odor.

- The air conditioner itself does not have undesirable odor. If there is odor, it may be due to accumulation of the odor in the environment.  
→ Clean the air filter or activate the cleaning function.

# Troubleshooting

There is sound of running water during the running of air conditioner.

- When the air conditioner is started up or stopped, or the compressor is started up or stopped during the running, sometimes the "hissing" sound of running water can be heard. → This is the sound of the flow of the refrigerant, not a malfunction.

A slight "click" sound is heard at the of start-up or shut-down.

- Due to temperature changes, panel and other parts will swell, causing the sound of friction.  
→ This is normal, not a fault.

The indoor unit makes abnormal sound.

- The sound of fan or compressor relay switched on or off.
- When the defrosting is started or stop running, it will create sound.  
→ That is due to the refrigerant flows to reverse direction. They are not malfunctions.
- Too much dust accumulation on the air filter of the indoor unit may result in fluctuation of the sound.  
→ Clean the air filters in time.
- Too much air noise when "Strong wind" is turned on.  
→ This is normal, if feeling uncomfortable, please deactivate the "Strong wind" function.

There are water drops over the surface of the indoor unit.

- When ambient humidity is high, water drops will be accumulated around the air outlet or the panel, etc.  
→ This is a normal physics phenomenon.
- Prolonged cooling run in open space produces water drops.  
→ Close the doors and windows.
- Too small opening angle of the louver blades may also result in water drops at the air inlet.  
→ Increase the angle of the louver blades.

During the cooling operation, the indoor unit outlet sometimes will blow out mist.

- When the indoor temperature and humidity are high, it happens sometimes.  
→ This is because the indoor air is cooled rapidly. After it runs for some time, the indoor temperature and humidity will be reduced and the mist will disappear.



**Immediately stop all operations and cut off the power supply , contact our Service center locally in following situations.**

- ▲ Hear any harsh sound or smell any awful odor during running.
- ▲ Abnormal heating of power cord and plug occurs.
- ▲ The unit or remote control has any foreign substance or water.
- ▲ Air switch or leakage protection switch is often disconnected.
- ▲ Fault code is displayed on the panel display of air conditioner:  
FA, Fb, F\*, E\*, P\*, L\* (\* represents the number 0 to 9).

# Notices for installation

## ⓘ Important notices

- Before installing, please contact with local authorized maintenance center, if unit is not installed by the authorized maintenance center, the malfunction may not solved, due to discommodious contact.
- The air conditioner must be installed by professionals according to the national wiring rules and this manual.
- To move and install air conditioner to another place, please contact our local special service center.

## Requirements for installation position

- Avoid places of inflammable or explosive gas leakage or where there are strongly aggressive gases.
- Avoid places subject to strong artificial electric/magnetic fields.
- Avoid places subject to noise and resonance.
- Avoid severe natural conditions (e.g. heavy lampblack, strong sandy wind, direct sunshine or high temperature heat sources).
- Avoid places within the reach of children.
- Shorten the connection between the indoor and outdoor units.
- Select where it is easy to perform service and repair and where the ventilation good.
- The outdoor unit shall not be installed in any way that could occupy an aisle, stairway, exit, fire escape, catwalk or any other public area.
- The outdoor unit shall be installed as far as possible from the doors and windows of the neighbors as well as the green plants.

## Requirements of the mounting structure

- The mounting rack must meet the relevant national or industrial standards in terms of strength with welding and connection areas rustproofed.
- The mounting rack and its load carry surface shall be able to withstand 4 times or above the weight of the unit, or 200kg, whichever is heavier.
- The mounting rack of the outdoor unit shall be fastened with expansion bolt.
- Ensure the secure installation regardless of what type of wall on which it is installed, to prevent potential dropping that could hurt people.

# Notices for installation

## Installation environment inspection

- Check nameplate of outdoor unit to make sure whether the refrigerant is R32.
- Check the floor space of the room. The space shall not be less than usable space(5m<sup>2</sup>) in the specification. The outdoor unit shall be installed at a well-ventilated place.
- Check the surrounding environment of installation site: R32 shall not be installed in the enclosed reserved space of a building.
- When using electric drill to make holes in the wall, check first whether there is pre-buried pipeline for water, electricity and gas. It is suggested to use the reserved hole in the roof of the wall.

## Unpacking Inspection

- Open the box and check air conditioner in area with good ventilation (open the door and window) and without ignition source. Note: Operators are required to wear anti-static devices.
- It is necessary to check by professional whether there is refrigerant leakage before opening the box of outdoor machine; stop installing the air conditioner if leakage is found.
- The fire prevention equipment and anti-static precautions shall be prepared well before checking. Then check the refrigerant pipeline to see if there is any collision traces, and whether the outlook is good.

## Safety Principles for Installing Air Conditioner

- Fire prevention device shall be prepared before installation.
- Keep installing site ventilated.(open the door and window)
- Ignition source,smoking and calling is not allowed to exist in area where R32 refrigerant located.
- Anti-static precautions in necessary for installing air conditioner, e.g. wear pure cotton clothes and gloves.
- Keep leak detector in working state during the installation.
- If R32 refrigerant leakage occurs during the installation, you shall immediately detect the concentration in indoor environment until it reaches a safe level. If refrigerant leakage affects the performance of the air conditioner, please immediately stop the operation, and the air conditioner must be vacuumed firstly and be returned to the maintenance station for processing.
- Keep electric appliance, power switch, plug, socket, high temperature heat source and high static away from the area underneath sidelines of the indoor unit.
- The air conditioner shall be installed in an accessible location to installation and maintenance, without obstacles that may block air inlets or outlets of indoor/outdoor units, and shall keep away from heat source, inflammable or explosive conditions.
- Use new connection pipe, unless re-flaring the pipe.

# Notices for installation

- When installing or repairing the air conditioner and the connecting line is not long enough, the entire connecting line shall be replaced with the connecting line of the original specification; extension is not allowed.

## Requirements for operations at raised height

- When carrying out installation at 2m or higher above the base level, safety belts must be worn and ropes of sufficient strength be securely fasten to the outdoor unit, to prevent falling that could cause personal injury or death as well as property loss.

## Electrical safety requirements

- Be sure to use the rated voltage and air conditioners dedicated circuit for the power supply, and the power cord diameter must meet the national requirements.
- When the maximum current of air conditioner is  $\geq 16A$ , it must use the air switch or leakage protection switch equipped with protection devices.
- The normal operating range is 90%-110% of the local rated voltage.
- The minimum clearance between the air conditioner and the combustibles is 1.5 m.
- The power cable enables communication between the indoor and outdoor units. You must first choose the right cable size before preparing it for connection.
- Cable Types: Indoor Power Cord(if applicable): H05VV-F; Outdoor Power Cord:H07RN-F or H05RN-F; Power Cable: H07RN-F or H05RN-F;
- Minimum Cross-Sectional Area of Power and Power Cables  

North America	Other Regions
---------------	---------------

Appliance Amps(A)	AWG
10	18
13	16
18	14
25	12
30	10
40	8

Rated Current of Appliance(A)	Nominal Cross-Sectional Area(mm <sup>2</sup> )
>3 and ≤ 6	0.75
>6 and ≤ 10	1
>10 and ≤ 16	1.5
>16 and ≤ 25	2.5
>25 and ≤ 32	4
>32 and ≤ 40	6

Note:  
If the length of power cable >8m, choose a larger size.

- The size of the power cord, power cable, fuse, and switch needed is determined by the maximum current of the unit. The maximum current is indicated on the nameplate located on the side panel of the unit. Refer to this nameplate to choose the right cable, fuse, or switch.
- Note: Core number of cable refer to the detailed wiring diagram adhered on the unit which you purchased.

# Notices for installation

## Grounding requirements

- The air conditioner is the type I electrical appliance and must ensure a reliable grounding.
- Do not connect the grounding wire to a gas pipe, water pipe, lightning rod, telephone line, or a circuit poorly grounded to the earth.
- The grounding wire is specially designed and shall not be used for other purpose, nor shall it be fastened with a common tapping screw.
- Interconnection cord diameter should be recommended as per instruction manual, and with type O terminal that meet local standards (internal diameter of type O terminal needs to match the screw size of the unit, no more than 4.2mm). After installation, check the screws whether have been fixed effectively, and there is no risk of loosening.

## Others

- the connection method between the air conditioner and the power line and the interconnection method of each independent element shall be based on the circuit diagram pasted on the machine subject to.
- the model and rating of fuse shall be subject to the silk screen identification on the corresponding controller or fuse sleeve.
- the auxiliary electric heater is a ceramic PTC electric heating element, and the rated power shall be subject to the nameplate data pasted on the machine.
- keep a distance of 12mm between the auxiliary electric heater and the shell to prevent fire caused by combustion.
- if the auxiliary electric heater, PTC and protection device are damaged, they shall be replaced by professionals and provided by the company components supplied.

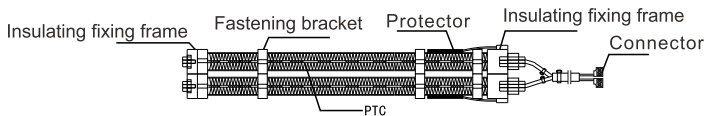

**Note: This is just schematic plan, please refer to the actual product.**

## Packing list

### Packing list of the indoor unit

Name	Quantity
Indoor unit	1 Set
* Remote controller	1 PC
* Batteries (7#)	2 PC
Instructions	1 Set
* Drain pipe	1 PC

### Packing list of the outdoor unit

Name	Quantity
Outdoor unit	1 Set
* Connection pipe	2 PC
* Plastic strap	1 ROLL
* Pipe protection ring	1 PC
* Luting (putty)	1 PACKET

**Note: Optional parts\* ),some models without.**

In some models, signed \* things place in the indoor unit .

The above fittings may be different from the actual products; please refer to the actual products.

# Installation for indoor unit

## Dimension drawing of indoor unit installation

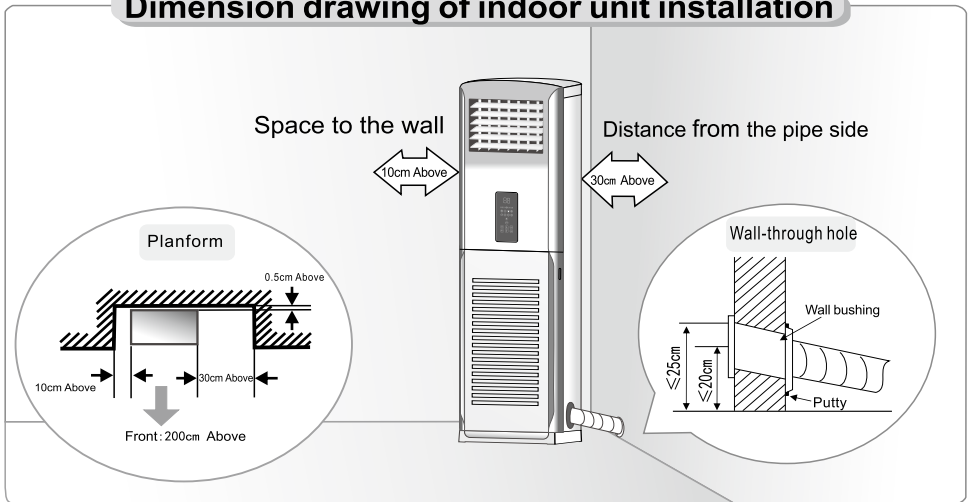

## Wall-through hole

1. Make the piping hole in the wall at a slight downward slant to the outdoor side.
2. Insert the piping-hole sleeve into the hole to prevent the connection piping and wiring from being damaged when passing through the hole.
3. The center of the hole in the wall shall not be more than 20 cm from the bottom of the air conditioner and the highest point of the hole shall not be more than 25 cm from the bottom to prevent water leak.

## Installation procedure

1. Loosen and remove the lower panel.
2. Butt the connecting pipes and wrap them together with the water pipes and the connecting wires (Note :In some models, connecting wires inside the electric control box have been connected in the factory, while in the rest models, the connecting wires are not connected. The clients may need to connect it by themselves. Please connect the wire according to the wiring diagram on the controller box cover of indoor unit ), then fasten the wrapped pipes with the press plate.
4. Depending on the position of the hole in the wall with respect to the body, select left or right pipe outlet on the back, cut off the cutting-stock of the rodent baffle and keep the remaining to protect the unit from rodents.

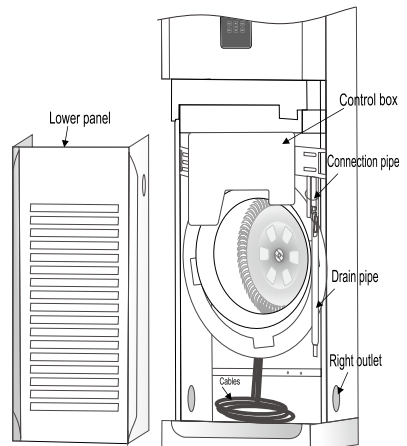

# Installation for indoor unit

5. Power cord may be routed out separately from the pipeline and through the back from the left or right side as required.
6. After the installation of the panel, move the indoor unit to a corner of the room or next to a wall, making it as close as possible to the wall as long as the minimum distance is allowed.

## Drain pipe connection

1. The drain pipe shall be tilted from inside to outside in order to drain the condensate water easily.
2. The joint shall be tightened, and its indoor part shall be wrapped with thermal insulation material.
3. Properly route the connection pipe, power cable, signal connection cable and drain pipe when wrapping, to avoid the concave-convex of drain pipe.

**Note:** After the drain pipe out of the wall, the outdoor part shall not be higher than the wall hole, i.e. not higher than 30cm, to avoid the backflow of condensate water.

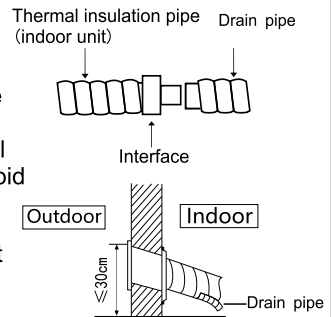

## Install the connection pipe

Uncoil the connection pipe, and bend the connection pipe according to your required length, unscrew the nuts of the pipe of the indoor unit, align the conical joint of connection pipe with the center of the corresponding pipe of indoor unit, tighten the nut by hand, and then tighten it again with torque wrench. The torques used are shown in the following table:

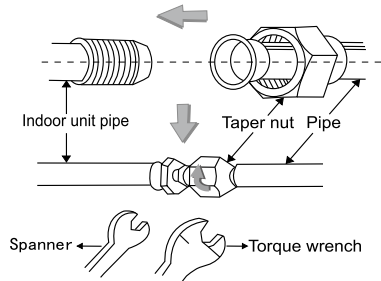

**Tightening torque table**

The size of pipe(mm)	Torque(N · m)
Φ6/Φ6.35	15~25
Φ9/Φ9.52	35~40
Φ12/Φ12.7	45~60
Φ15.88	73~78
Φ19.05	75~80

**Note:** Firstly connect the connection pipe to indoor unit, then to outdoor unit; pay attention to the bending, do not damage the connection pipe; the joint nut couldn't lighten too much, otherwise it may cause leakage.

# Installation for indoor unit

## Install the panel

1. Wrap the connecting pipe, connecting cable and water pipe together with a packaging tape.

- Do not wrap it too tight.
- The connector of the connecting pipe shall be first avoided during the wrapping for subsequent leak test.

2. Depending on the installation position, cut off one of the two cutting stock and run the wrapped pipe and cable through the hole left.

- Power cord may be routed out separately from the pipe-line, from the hole as required.

3. Finally install the trim panel.

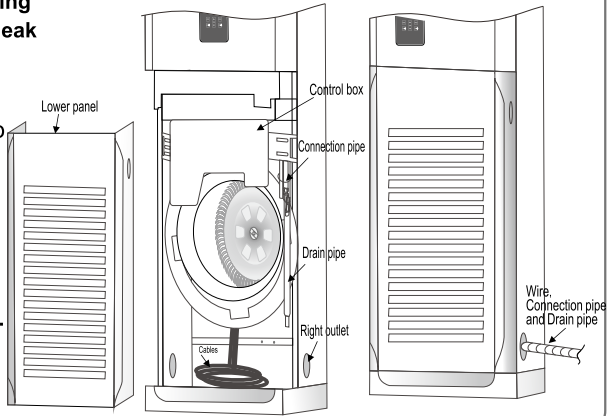

## Install the anti-collapse chain

- In order to prevent accidental collapse of indoor unit, please install the anti-collapse chain.

**Installation steps:**

1. Remove the screw of anti-collapse hole at the top cover of indoor unit;
2. Take out the anti-collapse chain and put it into the anti-collapse hole, and then tighten it with screw;
3. Fix the other end of anti-collapse chain on the wall with screw.

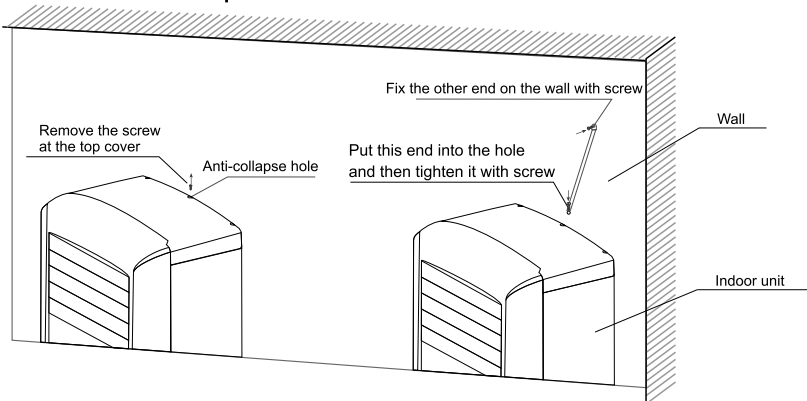

The above fig may be different from the actual products, please refer to the actual products.

# Installation for outdoor unit

## Dimension drawing of outdoor unit installation

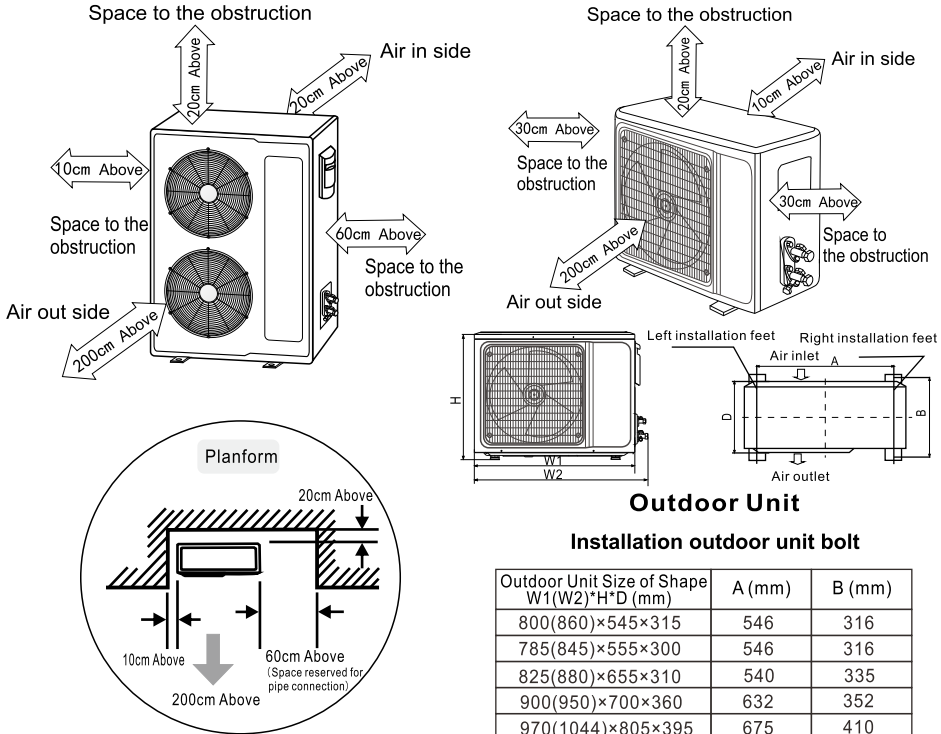

### Outdoor Unit

#### Installation outdoor unit bolt

Outdoor Unit Size of Shape W1(W2)*H*D (mm)	A (mm)	B (mm)
800(860)×545×315	546	316
785(845)×555×300	546	316
825(880)×655×310	540	335
900(950)×700×360	632	352
970(1044)×805×395	675	410
940(1010)×1320×370	625	364
940(1008)×1366×401	610	388

## Install the connection pipe

Connect the Outdoor Unit with Connection Pipe: Aim the counter-bore of the connection pipe at the shut off valve, and tighten the Taper nut with fingers. Then tighten the Taper nut with a torque wrench until the wrench makes a "click" sound.

### ★ Piping Length and Height

The maximum piping length (m)	Maximum height difference (m)
25	6

- Note:**
1. If the pipe length is greater than 5m but is less than 25m, add refrigerant according to 20g/m.
  2. The joints shall not be reused, unless after re-flaring the pipe.
  3. After installation, check the stop valve whether be fixed effectively.

**IMPORTANT:** If the unit with the quick connectors, please refer to the booklet of "Install the connection pipe(the unit with the quick connectors)".

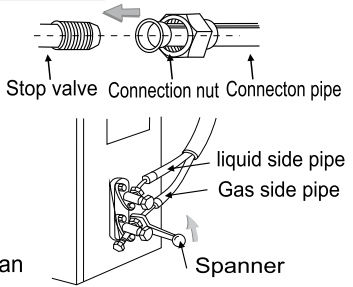

# Installation for outdoor unit

## Wiring Connection

### NOTE:

- ※ Yellow and green cord should be connected point with ⊕ mark.
  - ※ Don't reverse the power polarity.
  - ※ The wrong connection lead to the malfunction of some electrical parts.
  - ※ Must fix the screw of the firmly wire, then drag the wire lightly, confirmation whether it's firmly.
  - ※ Must changed if the wire slide, the self-drive screw can't used to the electric connection.
  - ※ The connection mark should be agreed on for indoor unit and outdoor unit.
- Unscrew the screw, take off the control panel cover from the unit.
  - Connect the cable to their terminals according to their number or colors.
  - The grounded wire connection:
    1. loosen the grounded screw of electrical shelf.
    2. Connect the grounded wire with the grounded screw then setscrew in the “⊕” mark formerly.
  - Fix the cable to the terminal board with fastening piece.
  - Reinstall the cover with the screw.

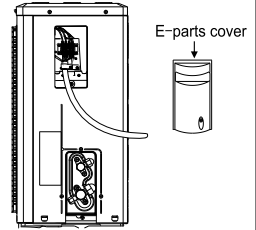

## Wiring diagram

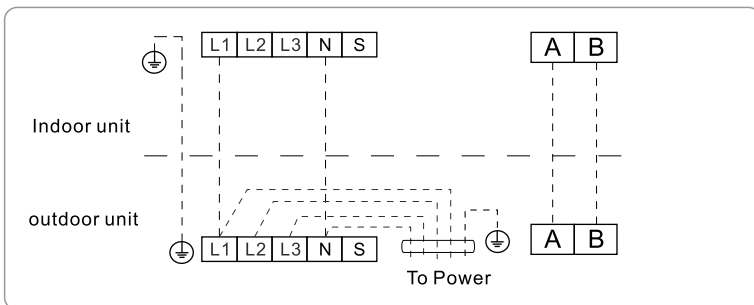
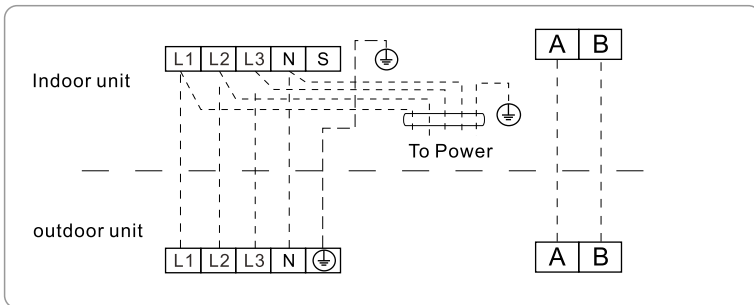

## Wiring diagram

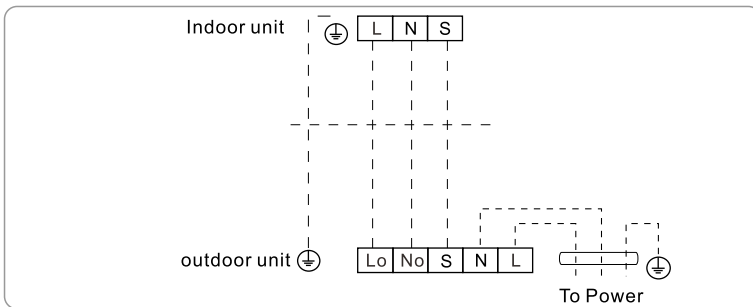
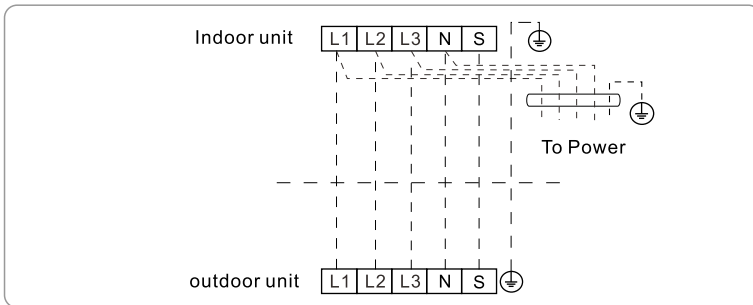
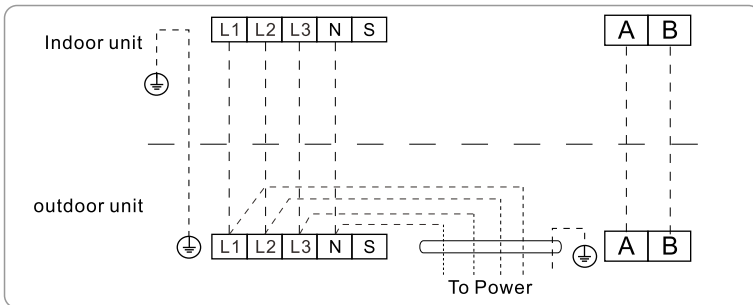

**NOTE:** ※The diagram are for reference only. If the entity is difference with this wiring diagram, please in order to the entity which you purchase.

※The detailed wiring diagram is on the controller box cover of indoor unit and E-parts cover of outdoor unit. Please connect the wire according to the wiring diagram and the different number or colors of wires.

# Installation for outdoor unit

## Expelling the air

### ● Outdoor unit refrigerant discharging method

After the pipe side connection is complete, proceed as follows.

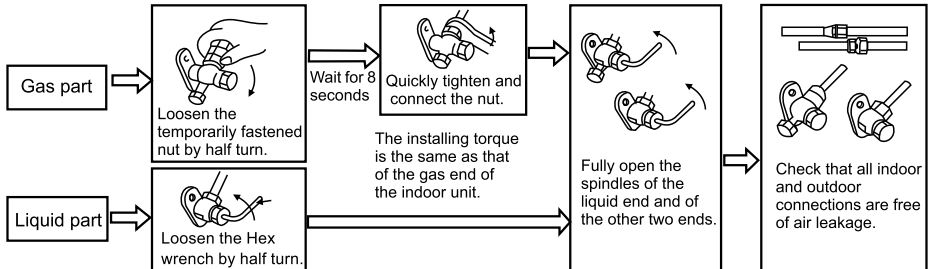

### ★ Exclusive R32 refrigerant pump must be used in making R32 refrigerant vacuum.

Before working on the air conditioner, remove the cover of the stop valve(gas and liquid valves)and be sure to retighten it afterward.(to prevent the potential air leakage)

1. To prevent air leakage and spilling tighten all connecting nut of all flare tubes.
2. Connect the stop valve, charge hose, manifold valve, and vacuum pump.
3. Fully open the handle Lo of the manifold valve and apply vacuum for at least 15 minutes and check that the compound vacuum gauge reads  $-0.1\text{MPa}(-76\text{cmHg})$ .
4. After applying vacuum, fully open the stop valve with a hex wrench.
5. Check that both indoor and outdoor connections are free of air leakage.

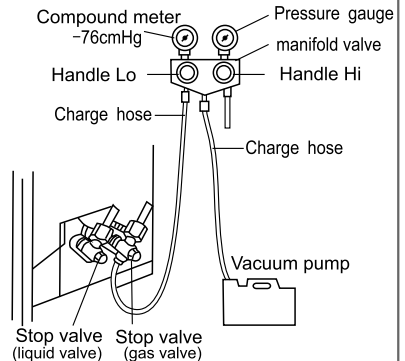

**IMPORTANT:** The unit with the quick connectors does not require vacuum pumping.

## Outdoor condensation drainage(Heat pump type only)

When the unit is heating, the condensing water and defrosting water can be out reliably through the drain house.

### Installation:

Install the outdoor drain elbow in  $\Phi 25$  hole on the base plate, and joint the drain hose to the elbow, so that the waste water formed in the outdoor unit can be drained out to a proper plate.

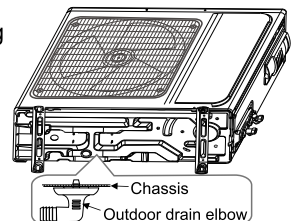

# Check after installation and test operation

## Check after installation

- Electric safety inspection

1. Grounding check: Check that the grounding line is earthed securely.
2. Electric leakage check (performed during the test run): During the test run after the installation of the air conditioner, the installers may check with an electric pen or multimeter the housing and other areas where electric leakage may occur, and, if there is indeed electric leakage, immediately stop the unit and carry out further inspection to determine the cause, and, if the installation problems are the culprit, resolve the problems before another test run, until the air conditioner runs safely and normally.
3. Check the refrigerant pipeline is protected well.

- Leak test of the refrigerant

Depending on the installation method, the following methods may be used to check for suspect leak, on areas such as the four connections of the outdoor unit and the cores of the cut-off valves and t-valves:

1. Bubble method: Apply of spray a uniform layer of soap water over the suspected leak spot and observe carefully for bubble.
2. Instrument method: Checking for leak by pointing the probe of the leak detector according to the instruction to the suspect points of leak.

Note: Make sure that the ventilation is good before checking.

## Test operation

- Make sure that pipes and wires are connected.
- Make sure that liquid side valve and air side valve both are completely open.
- Connect the wire to independent power source socket.
- Preparation of remote controller.
- Run the air-conditioner in cooling operation mode for 30 minutes or longer.
- Test the out and in air temperature.
- Make sure whether the outlet air temperature subtract from inlet's gives more than 10°C.

Note: Make sure that the ventilation is good before testing.

## Waste disposal

- After installation of the product, please don't throw away the waste (such as packaging materials), which shall be placed at the rubbish dump.
- When the product is damaged or replaced, please submit the waste to the professional recycling agency for disposal.

## Attention:

For maintenance or scrap, please contact authorized service centers.

Maintenance by unqualified person may cause dangers.

Feed air conditioner with R32 refrigerant, and maintain the air conditioner in strictly accordance with manufacturer's requirements. The chapter is mainly focused on special maintenance requirements for appliance with R32 refrigerant. Ask repairer to read after-sales technical service handbook for detailed information.

## Qualification requirements of maintenance personnel

- 1.Special training additional to usual refrigerating equipment repair procedures is required when equipment with flammable refrigerants is affected. In many countries, this training is carried out by national training organisations that are accredited to teach the relevant national competency standards that may be set in legislation. The achieved competence should be documented by a certificate.
- 2.The maintenance and repair of the air conditioner must be conducted according to the method recommended by the manufacturer. If other professionals are needed to help maintain and repair the equipment, it should be conducted under the supervision of individuals who have the qualification to repair AC equipped with flammable refrigerant.

## Inspection of the Site

Safety inspection must be taken before maintaining equipment with R32 refrigerant to make sure the risk of fire is minimized. Check whether the place is well ventilated, whether anti-static and fire prevention equipment is perfect.

While maintaining the refrigeration system, observe the following precautions before operating the system.

## Operating Procedures

### 1.General work area:

All maintenance staff and others working in the local area shall be instructed on the nature of work being carried out. Work in confined spaces shall be avoided. The area around the workspace shall be sectioned off. Ensure that the conditions within the area have been made safe by control of flammable material.

### 2. Checking for presence of refrigerant:

The area shall be checked with an appropriate refrigerant detector prior to and during work, to ensure the technician is aware of potentially toxic or flammable atmospheres. Ensure that the leak detection equipment being used is suitable for use with all applicable refrigerants, i.e.non-sparking, adequately sealed or intrinsically safe.

### 3.Presence of fire extinguisher:

If any hot work is to be conducted on the refrigeration equipment or any associated parts, appropriate fire extinguishing equipment shall be available to hand. Have a dry powder or CO<sub>2</sub> fire extinguisher adjacent to the charging area.

# Maintenance Notice

## 4.No ignition sources:

No person carrying out work in relation to a refrigeration system which involves exposing any pipe work shall use any sources of ignition in such a manner that it may lead to the risk of fire or explosion. All possible ignition sources, including cigarette smoking, should be kept sufficiently far away from the site of installation, repairing, removing and disposal, during which refrigerant can possibly be released to the surrounding space. Prior to work taking place, the area around the equipment is to be surveyed to make sure that there are no flammable hazards or ignition risks.

'No Smoking' signs shall be displayed.

## 5.Ventilated Area(open the door and window):

Ensure that the area is in the open or that it is adequately ventilated before breaking into the system or conducting any hot work. A degree of ventilation shall continue during the period that the work is carried out. The ventilation should safely disperse any released refrigerant and preferably expel it externally into the atmosphere.

## 6.Checks to the refrigeration equipment:

Where electrical components are being changed, they shall be fit for the purpose and to the correct specification. At all times the manufacturer's maintenance and service guidelines shall be followed. If in doubt, consult the manufacturer's technical department for assistance. The following checks shall be applied to installations using flammable refrigerants:

- The charge size is in accordance with the room size within which the refrigerant containing parts are installed.
- The ventilation machinery and outlets are operating adequately and are not obstructed.
- If an indirect refrigerating circuit is being used, the secondary circuit shall be checked for the presence of refrigerant.
- Refrigeration pipe or components are installed in a position where they are unlikely to be exposed to any substance which may corrode refrigerant containing components, unless the components are constructed of materials which are inherently resistant to being corroded or are suitably protected against being so corroded.

## 7.Checks to electrical devices:

Repair and maintenance to electrical components shall include initial safety checks and component inspection procedures. If a fault exists that could compromise safety, then no electrical supply shall be connected to the circuit until it is satisfactorily dealt with. If the fault cannot be corrected immediately but it is necessary to continue operation, an adequate temporary solution shall be used. This shall be reported to the owner of the equipment so all parties are advised.

Initial safety checks shall include:

- That capacitors are discharged: this shall be done in a safe manner to avoid possibility of sparking.
- That no live electrical components and wiring are exposed while charging, recovering or purging the system.
- Keep continuity of earthing.

## Inspection of Cable

Check the cable for wear, corrosion, overvoltage, vibration and check if there are sharp edges and other adverse effects in the surrounding environment. During the inspection, the impact of aging or the continuous vibration of the compressor and the fan on it should be taken into consideration.

## Leakage check of R32 refrigerant

Note: Check the leakage of the refrigerant in an environment where there is no potential ignition source. No halogen probe (or any other detector that uses an open flame) should be used.

Leak detection method:

For systems with refrigerant R32, electronic leak detection instrument is available to detect and leak detection should not be conducted in environment with refrigerant. Make sure the leak detector will not become a potential source of ignition, and is applicable to the measured refrigerant. Leak detector shall be set for the minimum ignitable fuel concentration (percentage) of the refrigerant. Calibrate and adjust to proper gas concentration (no more than 25%) with the used refrigerant.

The fluid used in leak detection is applicable to most refrigerants. But do not use chloride solvents to prevent the reaction between chlorine and refrigerants and the corrosion of copper pipeline.

If you suspect a leak, then remove all the fire from the scene or put out the fire.

If the location of the leak needs to be welded, then all refrigerants need to be recovered, or, isolate all refrigerants away from the leak site (using cut-off valve). Before and during the welding, use OFN to purify the entire system.

## Removal and Vacuum Pumping

1. Make sure there is no ignited fire source near the outlet of the vacuum pump and the ventilation is well.

2. Allow the maintenance and other operations of the refrigeration circuit should be carried out according to the general procedure, but the following best operations that the flammability is already taken into consideration are the key. You should follow the following procedures:

- Remove the refrigerant.
- Decontaminate the pipeline by inert gases.
- Evacuation.
- Decontaminate the pipeline by inert gases again.
- Cut or weld the pipeline.

3. The refrigerant should be returned to the appropriate storage tank. The system should be blown with oxygen free nitrogen to ensure safety. This process may need to be repeated for several times. This operation shall not be carried out using compressed air or oxygen.

# Maintenance Notice

4. Through blowing process, the system is charged into the anaerobic nitrogen to reach the working pressure under the vacuum state, then the oxygen free nitrogen is emitted to the atmosphere, and in the end, vacuumize the system. Repeat this process until all refrigerants in the system is cleared. After the final charging of the anaerobic nitrogen, discharge the gas into the atmosphere pressure, and then the system can be welded. This operation is necessary for welding the pipeline.

## Procedures of Charging Refrigerants

As a supplement to the general procedure, the following requirements need to be added:

- Make sure that there is no contamination among different refrigerants when using a refrigerant charging device. The pipeline for charging refrigerants should be as short as possible to reduce the residual of refrigerants in it.
- Storage tanks should remain vertically up.
- Make sure the grounding solutions are already taken before the refrigeration system is charged with refrigerants.
- After finishing the charging (or when it is not yet finished), label the mark on the system.
- Be careful not to overcharge refrigerants.

## Scrap and Recovery

### Scrap:

Before this procedure, the technical personnel shall be thoroughly familiar with the equipment and all its features, and make a recommended practice for refrigerant safe recovery. For recycling the refrigerant, shall analyze the refrigerant and oil samples before operation. Ensure the required power before the test.

1. Be familiar with the equipment and operation.
2. Disconnect power supply.
3. Before carrying out this process, you have to make sure:
  - If necessary, mechanical equipment operation should facilitate the operation of the refrigerant tank.
  - All personal protective equipment is effective and can be used correctly.
  - The whole recovery process should be carried out under the guidance of qualified personnel.
  - The recovering of equipment and storage tank should comply with the relevant national standards.
4. If possible, the refrigerating system should be vacuumized.
5. If the vacuum state can't be reached, you should extract the refrigerant in each part of the system from many places.
6. Before the start of the recovery, you should ensure that the capacity of the storage tank is sufficient.
7. Start and operate the recovery equipment according to the manufacturer's instructions.

8. Don't fill the tank to its full capacity (the liquid injection volume does not exceed 80% of the tank volume).
9. Even the duration is short, it must not exceed the maximum working pressure of the tank.
10. After the completion of the tank filling and the end of the operation process, you should make sure that the tanks and equipment should be removed quickly and all closing valves in the equipment are closed.
11. The recovered refrigerants are not allowed to be injected into another system before being purified and tested.

Note: The identification should be made after the appliance is scrapped and refrigerants are evacuated. The identification should contain the date and endorsement. Make sure the identification on the appliance can reflect the flammable refrigerants contained in this appliance.

## **Recovery:**

1. The clearance of refrigerants in the system is required when repairing or scrapping the appliance. It is recommended to completely remove the refrigerant.
2. Only a special refrigerant tank can be used when loading the refrigerant into the storage tank. Make sure the capacity of the tank is appropriate to the refrigerant injection quantity in the entire system. All tanks intended to be used for the recovery of refrigerants should have a refrigerant identification (i.e. refrigerant recovery tank). Storage tanks should be equipped with pressure relief valves and globe valves and they should be in a good condition. If possible, empty tanks should be evacuated and maintained at room temperature before use.
3. The recovery equipment should be kept in a good working condition and equipped with equipment operating instructions for easy access. The equipment should be suitable for the recovery of R32 refrigerants. Besides, there should be a qualified weighting apparatus which can be normally used. The hose should be linked with detachable connection joint of zero leakage rate and be kept in a good condition. Before using the recovery equipment, check if it is in a good condition and if it gets perfect maintenance. Check if all electrical components are sealed to prevent the leakage of the refrigerant and the fire caused by it. If you have any question, please consult the manufacturer.
4. The recovered refrigerant shall be loaded in the appropriate storage tanks, attached with a transporting instruction, and returned to the refrigerant manufacturer. Don't mix refrigerant in recovery equipment, especially a storage tank.
5. The space loading R32 refrigeration can't be enclosed in the process of transportation. Take anti electrostatic measures if necessary in transportation. In the process of transport, loading and unloading, necessary protective measures must be taken to protect the air conditioner to ensure that the air conditioner is not damaged.
6. When removing the compressor or clearing the compressor oil, make sure the compressor is pumped to an appropriate level to ensure that there is no residual R32 refrigerants in the lubricating oil. The vacuum pumping should be carried out before the compressor is returned to the supplier. Ensure the safety when discharging oil from the system.

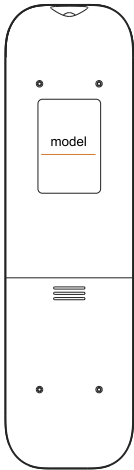

### ★Remote controller instructions

Users can scan the following QR code to obtain instructions

	
<p>YKR-H/101E</p> <p>NOTE: ✘The model of the remote control is show on the back.</p>	

### ★WIFI instructions

Users can scan the following QR code to obtain Wifi operation instructions.

	 For Android    For IOS
<p>1.This QR code is the instruction for using WIFI</p>	<p>2.Download the WIFI app through this QR code</p>
<p><b>Note: Some models do not have this function, please subject to the actual purchase.</b></p>	